

# API0 Telephone Interface



Installation & Operation Manual

**ClearOne**<sup>®</sup>  
You're Virtually There<sup>SM</sup>



---

© 2002 ClearOne Communications, Inc. All rights reserved. No part of this document may be reproduced in any form or by any means without written permission from ClearOne Communications, Inc. Printed in the United States of America. ClearOne Communications reserves specific privileges. Information in this document is subject to change without notice.

AP10 Installation and Operation  
Manual  
ClearOne Part No. 800-150-201  
June 2002 (Rev. 2.0)



---

# AP10 Installation and Operation Manual

## Table of Contents

<b>CHAPTER 1: Introduction</b>	<b>1</b>
Features	1
Professional Services Group	2
Product registration	2
Product returns	2
Unpacking	3
Controls and Connections	3
Front view	3
Rear view	4
Before You Install	5
Power requirements	5
Telephone line requirements	5
Equipment placement	5
Environmental requirements	5
<b>CHAPTER 2: Installation</b>	<b>7</b>
Hardware Setup	7
Connect the unit	7
Creating a G-Link network	8
Assigning device ID numbers	9
Connecting power	10
<b>CHAPTER 3: Configuration</b>	<b>11</b>
DIP Switch Settings	11
Noise Burst/Auto-Adapt	11
Receive Boost	11
Receive AGC	12
Auto-Answer	12
Auto-Disconnect	12
Call Progression/Loop	12



---

Receive Reduction .....	13
Calibration .....	13
Noise Burst Adapt .....	13
Auto-Adapt .....	14
Transmit level adjustment .....	14
Receive level adjustment .....	14
<b>CHAPTER 4: Operation .....</b>	<b>15</b>
Using the AP10 .....	15
To answer a call .....	15
To make and disconnect a call .....	15
Using the Telco Interface .....	16
To make and disconnect a call .....	16
To mute .....	17
Other telco options .....	17
Controllers .....	17
Custom control through DB-25 port .....	17
Touch panel control .....	17
<b>APPENDICES .....</b>	<b>19</b>
Appendix A: Specifications .....	19
Appendix B: Pinouts .....	20
Appendix C: Serial Commands .....	21
Appendix D: Warranty .....	28
Appendix E: Compliance .....	30
Appendix F: Block Diagram .....	32
Glossary .....	33
Index .....	35

# CHAPTER 1: Introduction

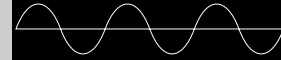

Congratulations on purchasing the Audio Perfect® telephone interface. The AP10 uses advanced digital technology to maintain the highest possible audio quality. The AP10 is designed as an accessory to the AP800 (echo cancelling, audio processing, microphone mixing matrix) and enables the AP800 to connect to a standard telephone line.

The AP10 is a single-line digital hybrid which uses digital signal processing (DSP) to separate the transmit and receive audio—eliminating distortion, weak signals, and feedback. It continually filters low and high frequency noise to provide pure sound.

## Features

- Easy to install and operate
- DTMF dialing capability
- Simultaneous two-wire/four-wire operation within an Audio Perfect system
- G-Link network interconnection with up to eight AP800s and 16 AP10s
- 9.6kHz sampling rate allows continual adaptation to telephone-line conditions
- Full-time telco echo cancellation with 26 millisecond tail time
- Conference up to 16 callers (with 16 AP10s) within an Audio Perfect system
- Digital anti-alias filter minimizes hum and Central Office switching noise
- Remote On/Off control via serial commands or rear-panel connection
- Digital send filter/limiter for telephone line noise reduction
- Compatible with any analog telephone system
- No outside RF interference will affect performance



## Professional Services Group

If you need additional information on how to install, set up, or operate your system, please contact us at one of the locations listed below. We welcome and encourage your comments so we can continue to improve our products and serve your needs.

ClearOne Communications ~ 1825 Research Way ~ Salt Lake City, UT 84119

### Technical Support

Telephone: 1.800.283.5936 (USA) or 1.801.974.3760  
Fax: 1.801.977.0087  
E-mail: [tech.support@clearone.com](mailto:tech.support@clearone.com)  
Web site: [www.clearone.com](http://www.clearone.com)

### Sales and Customer Service

Telephone: 1.800.945.7730 (USA) or 1.801.975.7200  
Fax: 1.800.933.5107 (USA) or 1.801.977.0087  
E-mail: [sales@clearone.com](mailto:sales@clearone.com)

### ClearOne Communications EuMEA GmbH

Leonhardstr. 16-18, D-90443 Nuremberg, Germany

Telephone: +49 911 955159-0  
Fax: +49 911 955159-10  
E-mail: [global@clearone.com](mailto:global@clearone.com)

### Product registration

Please register your AP10 online by visiting ClearOne Technical Support at **[www.clearone.com](http://www.clearone.com)**. When your product is properly registered, ClearOne Communications is better able to serve you should you require technical assistance. Registration information is also used to notify you of upgrades and new product information.

### Product returns

All product returns require a return authorization (RA) number. Please contact the Technical Services Group before attempting to return your AP10 unit.

## Unpacking

Ensure that the following items were received with your shipment:

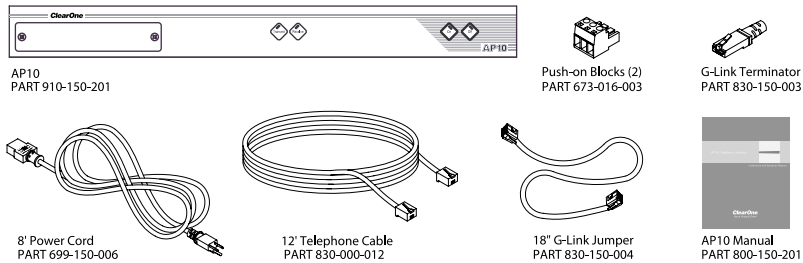

Figure 1.1. AP10 unpacking diagram

**!** ClearOne is not responsible for product damage incurred during shipment. You must make claims directly with the carrier. Inspect your shipment carefully for obvious signs of damage. If the shipment appears to be damaged, retain the original boxes and packing material for inspection by the carrier. Contact your carrier immediately.

## Controls and Connections

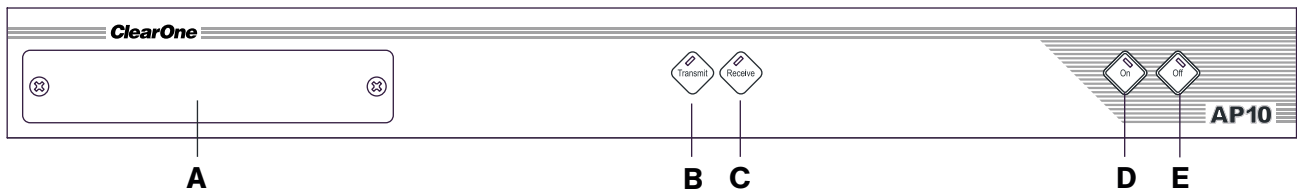

Figure 1.2. AP10 front panel controls

### Front view

- A. **DIP switches.** Operational features can be enabled or disabled via DIP switches behind this panel. These features include auto-answer, auto-disconnect, momentary or latching mode, device identification, caller AGC, caller boost, and noise burst adapt/self adapt.
- B. **Transmit LED.** This bicolor LED indicates the audio levels being transmitted from the room to the telephone line.
- C. **Receive LED.** This bicolor LED indicates the audio level the room is receiving from the telephone line.
- D. **On.** The On button connects the AP10 to the telephone line (dependent upon DIP switch settings) and automatically adapts the hybrid to the line. The LED will illuminate green when the hybrid is in the On state.
- E. **Off.** The Off button disconnects the hybrid from the telephone line and mutes all audio. The LED indicates the hybrid's Off state. The LED will illuminate red when the hybrid is in the Off state.

Pressing and holding the On button for more than a half-second while the hybrid is active will readapt the hybrid.

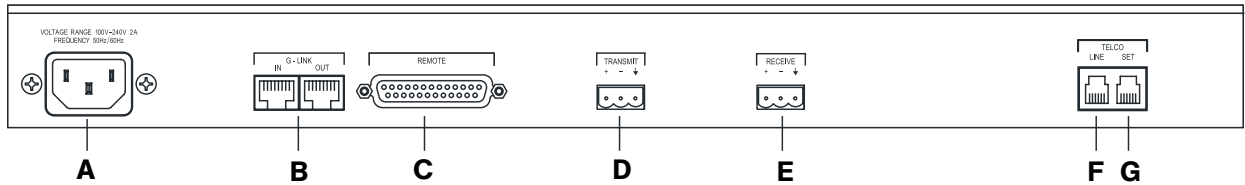

Figure 1.3. AP10 rear-panel connectors

## Rear view

- A. **Power.** The AC power cord input is a NEMA-type connector allowing 100–240VAC, 50/60Hz.
- B. **G-Link In, Out.** This RJ-45 connector is used to connect the AP10 to the AP800 for control. AP-Ware is capable of accessing and controlling a G-Link local area network (LAN) of up to eight AP800/AP400 units and 16 AP10 units. G-Link supports a distance of up to 20 feet between each connected unit.
- C. **Remote.** This DB-25 connector provides control and status of the AP10 and unbalanced audio. See Appendix B for pinouts.
- D. **Transmit Input.** This Phoenix connector is used to connect transmit audio (input) from the AP800 to the AP10, which is then sent to the telephone line.
- E. **Receive Output.** This Phoenix connector is used to connect receive audio (telephone participant audio) from the AP10 to the AP800.
- F. **Telco Line.** This RJ-11 connector provides connection of a standard analog telephone line to the hybrid.
- G. **Telco Set.** This RJ-11 connector allows connection to a standard telephone set. Tip and ring from the phone line are present at this connector when the hybrid is in its off state. Tip and ring from the phone line are not present at this point when the hybrid is in its on state.





## Before You Install

### Power requirements

The AP10 automatically accommodates voltage requirements of 100–240VAC, 50/60Hz, 15W.

### Telephone line requirements

The AP10 model operates on a standard analog telephone line and connects to the telephone system with a standard RJ-11C modular jack. If you do not have an RJ-11C jack where you want to install your AP10, call your telephone company for installation.

### Equipment placement

The AP10 models are designed for installation in a standard 19-inch equipment rack. You can also purchase side panels for desktop placement.

### Environmental requirements

The AP10 can be safely operated in a room with varying temperatures between 32°F (0°C) and 100°F (38°C).





The AP10 is designed for easy installation and set-up. All connections are made through rear-panel connectors. This section provides instructions on installing the units in the rack and making initial connections, creating a G-Link network, and assigning device ID numbers.

The diagram below illustrates the typical connections that are made when adding an AP10 to an AP800.

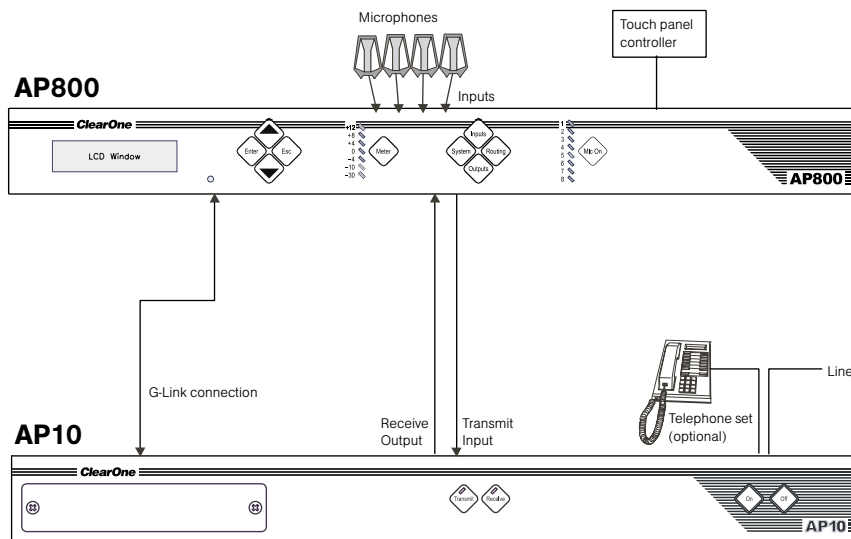

Figure 2.1. System diagram

## Hardware Setup

### Connect the unit

Refer to the rear-panel drawing in Figure 2.2 on the following page. Each connector is numbered for easy identification.

1. Place the unit in the rack and attach it securely. AP10 models are designed for installation in a standard 19-inch equipment rack.
2. Connect your telephone line from the wall jack to the RJ-11C Line jack [F].
3. Plug your telephone set into the RJ-11C Set jack [G].
4. If you are using a custom controller for control and hybrid status, plug it into the DB-25 Remote connector [C].

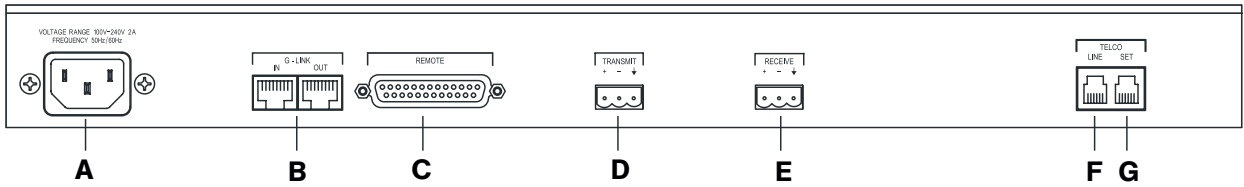



Figure 2.2. AP10 rear panel connectors

 The three terminals in the Phoenix connector correspond with the back-panel audio contacts (from left to right): + (positive), - (negative), and ↓ (ground).

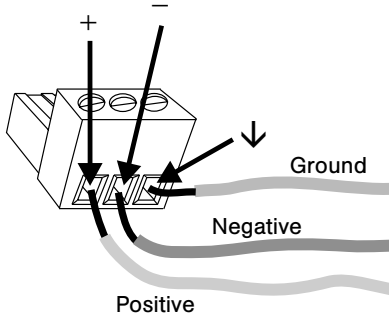

Figure 2.3. Phoenix push-on connector

5. Wire the AP10 to the AP800 using the provided three-terminal Phoenix push-on connectors. These connectors are designed for easy wiring; simply insert the desired wire into the appropriate connector opening and tighten down the top screw.

- **Transmit Input** Audio connected to the Transmit Input [D] will be sent down the telephone line.
- **Receive Output** Audio from the telephone participant is passed to Receive Output [E].

### Creating a G-Link network

1. Place the AP units in their proper locations. The back-panel G-Link In and G-Link Out [B] connectors are designed for setting up your G-Link network. G-Link connections between AP units are connected in daisy-chain fashion using category five twisted-pair cable.
2. The first ClearOne unit in the chain must have the G-Link In connector terminated with a G-Link terminator (provided).

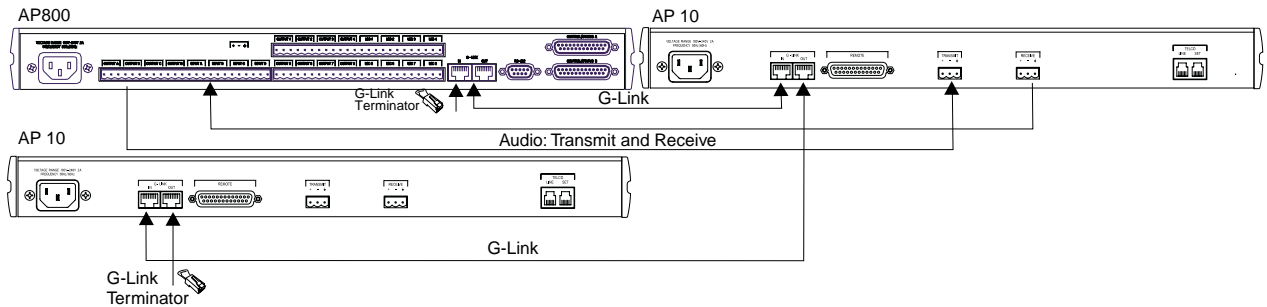

Figure 2.4. G-Link connection block diagram

3. The first ClearOne unit's G-Link Out connector is then attached to the G-Link In connector on the next unit in the chain. At the end of the network, the final unit must have the G-Link Out connector terminated with a G-Link terminator as well.

A G-Link network will allow interconnection of up to 16 AP10s and eight AP800s. If the AP units are stacked vertically, connect them using the short RJ-45 jumper (provided). If networking over longer distances (up to 20 feet/ 6.1 meters between units), use Cat 5 twisted-pair (10BaseT LAN) cable.



## Assigning device ID numbers

Once your physical G-Link network is established, you need to set up unique G-Link device ID numbers for each AP10 on the network. As shipped from the factory, all AP10 units default as binary address 0. Set device ID numbers for each AP10 unit at your site by manipulating front-panel DIP switches 9–12, selecting/deselecting each switch to set up address 0–15 in binary code. Use the table below to determine the proper DIP switch settings for the device ID you want to assign.

**!** If more than one AP10 is assigned the same device ID number, the Transmit and Receive LEDs will flash red and green on the affected units until the error is corrected.

### Device ID DIP switch settings

Binary Address	DIP Switch 9 Position	DIP Switch 10 Position	DIP Switch 11 Position	DIP Switch 12 Position
0	0 (DOWN)	0 (DOWN)	0 (DOWN)	0 (DOWN)
1	0 (DOWN)	0 (DOWN)	0 (DOWN)	1 (UP)
2	0 (DOWN)	0 (DOWN)	1 (UP)	0 (DOWN)
3	0 (DOWN)	0 (DOWN)	1 (UP)	1 (UP)
4	0 (DOWN)	1 (UP)	0 (DOWN)	0 (DOWN)
5	0 (DOWN)	1 (UP)	0 (DOWN)	1 (UP)
6	0 (DOWN)	1 (UP)	1 (UP)	0 (DOWN)
7	0 (DOWN)	1 (UP)	1 (UP)	1 (UP)
8	1 (UP)	0 (DOWN)	0 (DOWN)	0 (DOWN)
9	1 (UP)	0 (DOWN)	0 (DOWN)	1 (UP)
10 (A)	1 (UP)	0 (DOWN)	1 (UP)	0 (DOWN)
11 (B)	1 (UP)	0 (DOWN)	1 (UP)	1 (UP)
12 (C)	1 (UP)	1 (UP)	0 (DOWN)	0 (DOWN)
13 (D)	1 (UP)	1 (UP)	0 (DOWN)	1 (UP)
14 (E)	1 (UP)	1 (UP)	1 (UP)	0 (DOWN)
15 (F)	1 (UP)	1 (UP)	1 (UP)	1 (UP)

## Connecting power

The power input [1] will operate at any level between 100–240VAC, 50–60Hz, 15W (typical). Plug in the AP10 to complete the hardware installation.



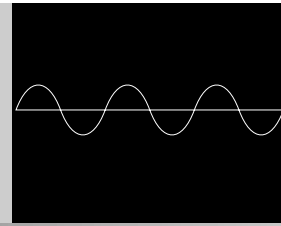

## DIP Switch Settings

The AP10 has a variety of operational features configurable through DIP switch settings, including noise burst/auto-adapt, receive AGC control, auto-answer, auto-disconnect, call progression/loop, receive reduction, and hook-flash duration. Default settings (as shipped from the factory) are denoted by an asterisk "\*".

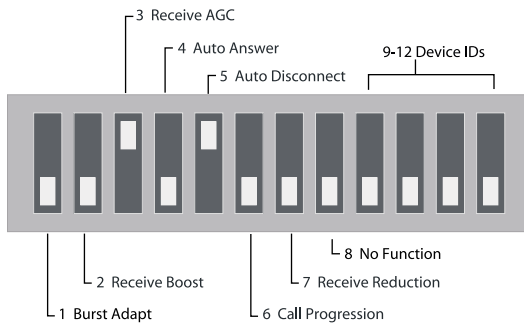

Figure 3.1. AP10 DIP switches

### Noise burst/auto-adapt

In some applications, you might want to adapt the hybrid with a white noise burst, rather than allow the hybrid to adapt automatically to line conditions. To enable this feature, set DIP switch 1 to the On position.

DIP Switch	Position	Description
1	On (up)	Burst adapt
1*	Off (down)	Auto-adapt

### Receive boost

If incoming caller audio is consistently low, activate the Receive Boost. This will increase receive audio by 6dB. To enable this feature, set DIP switch 2 to the On position.

DIP Switch	Position	Description
2	On (up)	6dB Receive audio boost enabled
2*	Off (down)	6dB Receive audio boost disabled



## Receive AGC

DIP switch 3 enables/disables the automatic gain control (AGC) function in the firmware. The AGC feature is designed to keep soft and loud telephone participants at a consistent level.

DIP Switch	Position	Description
3*	On (up)	Receive AGC enabled
3	Off (down)	Receive AGC disabled

## Auto-answer

DIP switch 4 enables/disables auto-answer. When enabled, the AP10 will automatically answer incoming calls after one complete valid ring has been detected.

DIP Switch	Position	Description
4	On (up)	Auto-answer enabled
4*	Off (down)	Auto-answer disabled (follows the serial command)

 To issue the AA (auto-answer) serial command to toggle auto-answer, DIP switch 4 must be off (down).

## Auto-disconnect

DIP switch 5 enables/disables auto-disconnect.

DIP Switch	Position	Description
5*	On (up)	Auto-disconnect enabled
5	Off (down)	Auto-disconnect disabled

 In order for the settings on DIP Switch 6 to function, DIP Switch 5 must be on (up). Auto-disconnect must be enabled before either Call Progression or Loop Drop are applicable.

## Call progression/loop

DIP switch 6 selects either loop drop or call-progress mode. Call-progress mode will disconnect the line upon detection of a valid call-progress signal. Call progress will detect the reorder tone and busy signal for the U.S., Canada, United Kingdom, France, and Germany.

DIP Switch	Position	Description
6	On (up)	Call progression enabled
6*	Off (down)	Loop drop enabled





## Receive reduction

In some applications, it might be necessary to duck (lower) the receive audio coming in through the telephone line when transmit audio is present. To enable receive reduction, set DIP switch 7 to the On position.

DIP Switch	Position	Description
7	On (up)	Receive reduction enabled
7*	Off (down)	Receive reduction disabled

## Calibration

The following information will help you make adjustments to optimize your system performance. Verify all components and all connections. Ensure that proper power is supplied to the AP10 and that the unit is off (indicated by the red Off LED). If the green On LED is lit, press the Off button [E].

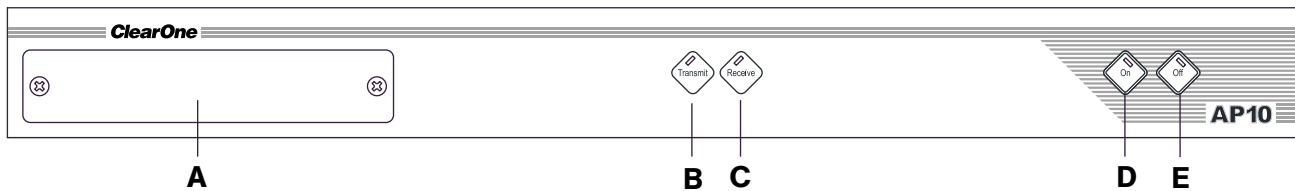



Figure 3.2. AP10 front-panel controls

There are two calibration methods for the AP10: noise burst and auto-adapt. Which procedure is used depends on whether you have DIP switch 1 on (up) for noise-burst adapt, or DIP switch 1 Off (down) for auto-adapt. Either will suffice to calibrate the AP10. The difference is the application and/or personal preference. Some applications are not suited for a .75-second noise burst, and might require the gradual adaptation over time.

 Some echo and ringing might be heard while calibrating the AP10. Disregard it and continue with calibration until the end of the procedure. The echo and ringing will disappear.

## Noise burst adapt

If DIP switch 1 is on (up), have someone call the AP10 from another location. Answer the line by pressing the On button [D]. (If the auto-answer feature is active, the unit will answer the call after one complete ring.)

The caller will hear a short white noise burst (it will sound like static) and a short beep. This automatically adapts the AP10 to the telephone line.

## Auto-adapt

If DIP switch 1 is off (down), call someone and continue to talk while the system gradually adapts over time. Once complete, the AP10 will be fully calibrated and ready for use. Press the Off button [E]. If the auto-disconnect feature is active, and the caller hangs up, the AP10 will disconnect upon sensing loop drop or call-progress tones, depending on the position of DIP switch 6.

## Transmit level adjustment

Someone in the local room should speak into the microphone at a normal distance, in a normal voice. The party at the distant location should not speak during the transmit adjustment. Adjust the AP800 output that is connected to the AP10 Transmit input to 0dB. The AP10 Transmit LED [B] should illuminate solid green while the person is speaking and extinguish when the person stops.

 AP10 transmit and receive audio level adjustments are made using the AP800. Nominal transmit and receive level for the AP10 is 0dBu.

## Receive level adjustment

Someone in the distant location should speak into the microphone at a normal distance, in a normal voice; the local room should maintain silence. Adjust the AP800 input that is connected to the AP10 Receive output to 0dB. The AP10 Receive LED [C] should be solid green while the person is speaking and extinguish when the person stops.

# CHAPTER 4: Operation

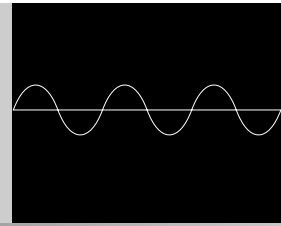

The AP10 has four basic functions: make a call, answer a call, disconnect a call, and mute. This chapter explains how to perform these functions with the AP10 unit and a telephone handset (optional) and with the Telco interface in AP-Ware. You can also use touch panels and custom control devices.

## Using the AP10

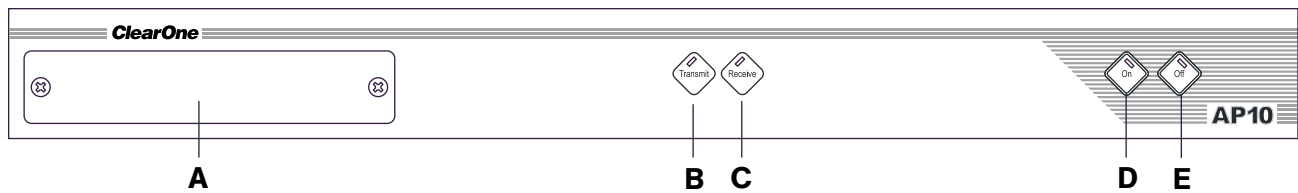

Figure 4.1. AP10 front panel controls

### To answer a call

Depending on how you have configured your AP10, an incoming call can ring on the telephone set connected to the AP10, the receive output, and pass a serial ring to the control device. An incoming call will also cause the front panel On LED to flash. You can answer the call in one of two ways:

- Press the **On** button [D] on either the front panel or from your remote control. This will route the call through the AP10 to the AP800. The green On LED will light. The red Off LED will extinguish.

– or –

- Answer the call by picking up the telephone handset and talking to your party over the telephone.

### To make and disconnect a call

1. Call the party using your handset.
2. After the other party has answered, route the call through the AP10 by pressing the **On** button [D]. The On LED will light and the AP10 will take control of the call, disabling the telephone set. You can now safely hang up the handset without disconnecting your call.

If using an external controller, it is not necessary to press the On button [D]. The DIAL serial command automatically engages the AP10. See Serial Commands, page 22.



If auto-answer is enabled (DIP switch 4), the AP10 will answer after the first complete ring.



If auto-disconnect is enabled (DIP switch 5), the AP10 will disconnect upon sensing loop drop or call-progress tones (depending on the position of DIP switch 6).

- When the conversation is complete, press the **Off** button [E] to disconnect the call. You can also disconnect using an external controller. If the handset is off hook, audio will be routed to the telephone.

If your call is through the handset only (the red Off LED will be lit), hang up when the conversation is complete.

## Using the Telco Interface

### To make and disconnect a call



- Open AP-Ware and select the AP10 unit.
- Click the **AP10 Telco** button on the Flow Screen to open the Telco interface.



Detailed instructions on creating site files and using AP-Ware can be found in the AP-Ware help file.



Figure 4.2. Telco dialing interface

- Activate the telephone interface by clicking **On** or by beginning to dial.
- When the green light below the On button illuminates, enter the number to be dialed, including any dial-out prefixes.
- Click **Send**. If you clicked directly on the number buttons, the call will be completed as you finish dialing—just like using a standard telephone.
- When you are finished with the call, click **Disconnect** to end the call.



## To mute

- Click **Mute TX** to mute the transmit audio (audio sent to the telephone line).
- Click **Mute RX** to mute the receive audio (audio from the telephone line).

## Other telco options

- **Hook-Flash.** This button sends a momentary interruption in line seizure to the telephone line.
- **Re-Null.** This feature sends a short noise burst down the telephone line and forces the AP10 to adapt to the telephone line.
- **Auto-Answer.** This button turns auto-answer on and off. If auto-answer is turned on, the AP10 answers the call after the first complete ring. If it is turned off, you will need to manually answer the call. You must have DIP switch 4 in the on (up) position.

## Controllers

### Custom control through DB-25 port

A customer-supplied remote control or contact-closure switch can be programmed to perform functions such as: mute on/off, system on, and system off. For pinouts, see Remote connector pinout, page 20.

### Touch panel control

The AP products are designed to function with touch panel control systems. The controller is connected to the AP800 RS-232 port. Through the G-Link network, all networked AP products can be accessed and controlled from that single point.

Using a touch panel, you can control the following: AP10 on or off control; transmit and receive audio mute; DTMF tone generation; volume control for receive audio; query of the AP10's binary address; re-nulling the telephone hybrid; metering of input and output, and ERL and ERLE. These commands are also available in the AP-Ware software, which communicates with the AP10 via an AP800 RS-232 serial port and the G-Link network.





## Appendix A: Specifications

### Dimensions (LxDxH)

17.25" x 10.25" x 1.75"  
43.8 x 26 x 4.5 cm

### Weight

7.5 lb/3.4 kg dry  
12.6 lb/5.7 kg shipping

### Operating Temperature

32–100° F  
0–38° C

### Humidity

0% to 80%, non-condensing

### Power Input Range

Auto-adjusting  
100–240VAC; 50/60Hz

### Power Consumption

8W typical

### Front Panel DIP Switches

Device Identification:  
4-position DIP switch  
Receive AGC  
Auto-Answer  
Auto-Disconnect  
Self-Adapt  
Disconnect on Loop or Loop and  
Call Progression  
Noise Burst Adapt  
Momentary On/Off  
Latching On/Off

### G-Link In/Out

Proprietary Network  
RJ-45 (2), 38.4kbps,  
110k $\Omega$  impedance  
Category five twisted-pair cable  
20' (6.1 meters) maximum cable  
length between two networked  
devices

### Control/Status

DB-25 female  
Inputs: active low (pull to ground)  
Outputs: Open collector, 40VDC  
max, 40mA each  
Unbalanced Transmit and Receive

### Telco Line

RJ-11  
POTS (plain old telephone service)  
or analog extension from a PBX  
A-lead supervision provided

### Telco Set

RJ-11  
Connect analog telephone set  
A-lead supervision provided

### Transmit Input

Push-on terminal block,  
balanced, bridging  
Impedance: >20k $\Omega$   
Nominal Level: 0dBu  
Maximum Level: 20dBu

### Receive Output

Push-on terminal block, balanced  
Impedance: <50 $\Omega$   
Nominal Level: 0dBu  
Maximum Level: 20dBu

### Audio Performance

Conditions: Unless otherwise  
specified, all measurements are  
performed with a 250Hz to 3.5kHz  
BW limit (no weighting). Reference  
to 0dBu at -15dBm on/off the  
telephone line (Receive AGC  
disabled).  
Frequency Response: 250Hz to  
3.5kHz,  $\pm$ 1dB  
SNR: >56dB  
THD+N: <0.3%

### Telco Echo Cancellation

TEC tail time: 31ms  
TEC null: 55dB nominal

### Approvals

FCC, CSA, CE

### Set-up Software

AP-Ware

## Appendix B: Pinouts

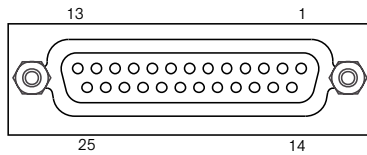

Figure B.1. Remote Port

### Remote connector pinout

Pin	Description
1	Remote On*
2	Remote Off*
3	N/C
4	N/C
5	Switch/Indicator Common
6	N/C
7	N/C
8	N/C
9	Unbalanced Transmit Audio Input (0dBu nominal)
10	Unbalanced Receive Audio Input (0dBu nominal)
11	NC
12	N/C
13	Audio Common
14	On indication**
15	Off indication**
16	N/C
17	N/C
18	Switch Indicator Common
19	Transmit Presence Indicator**
20	Receive Presence Indicator**
21	Switch Indicator Common
22	Audio Common
23	Audio Common
24	Audio Common
25	Switch Indicator Common

\* Remote control provided via contact closure to Switch/Indicator Common

\*\* Remote indicators provided via open collector outputs to Indicator Common (<40V, <40mA)





## Set connector pinout

Pin	Description	Pin	Description
1	To pin 6 of SET RJ-11C	4	Tip
2	To pin 5 of SET	5	To pin 2 of LINE
3	Ring	6	To pin 1 of LINE RJ-11C

## Line connector pinout

Pin	Description	Pin	Description
1	To pin 6 of LINE RJ-11C	4	Ring
2	To pin 5 of LINE	5	To pin 2 of SET
3	Tip	6	To pin 1 of SET RJ-11C

## Appendix C: Serial Commands

The AP10 accepts serial commands via the AP800's serial port; the commands are passed to the unit through the G-Link network. The commands in this manual pertain only to the AP10. RS-232 serial port protocol is 9,600 (default), 19,200, or 38,400 baud; 8 bits, 1 stop bit, no parity.

## Conventions

The following typographic conventions are used in this document to describe the different serial commands. Use the Command structure section and the examples as a guide when creating your serial commands.



<b>Convention</b>	<b>Description</b>
<X>	Parameters enclosed in < > indicate a mandatory parameter.
[X]	Parameters enclosed in [ ] indicate an optional parameter.
1-8	Parameters separated by a - indicate a range between the values.
4,7,9	Parameters separated by a , indicate a list of available values.
<b>EREF</b>	Words in uppercase bold indicate command text.
DEVICE	Indicates the device type and device number on the G-Link network. It is composed of a device type number and a device number. The device type for the AP10 is always 2 and the device ID will always be 0–0–9, A–F (where A=10 and F=15), or * (to select all AP10 units).

## Command structure

Commands can be either UPPERCASE or lowercase. Also, extra spaces or tabs between arguments in text commands is allowed. Return values are always in uppercase. For a command to be recognized by the serial port, the command must be terminated by a carriage return.

The structure of serial commands is as follows: #DEVICE **COMMAND** [X] [X]

#	indicates the start of a command line
DEVICE	represents the device type and device number
<b>COMMAND</b>	is the command text
[X] [X]	represents any additional options in the order that they appear in the command descriptions that follow

## Example

A command to enable auto-answer on the AP10 device "0" has the command line: #20 AA 1 1. In this command line, 2=AP10, 0=unit 0, AA=command, 1=Telco channel 1, 1=on state. If a command calls for a "null" value, leave a blank in the command line. For example, "#20 AA" returns the current auto-answer state on device 20.

For a command to be recognized by the serial port, it must be terminated by a carriage return.



## AP10 Serial Commands

Command	Function
AA	Sets auto-answer for a telco channel
DIAL	Dials a DTMF sequence or reports last sequence dialed
HOOK	Sends a hook flash to the telephone line
LVL	Reports the level of the transmit or receive channel (read only)
MUTE	Sets the mute for the transmit or receive channel
NULL	Re-nulls the AP10 to the telephone line
RING	Ring acknowledgement
TE	Selects/reports the connect state of the unit
TERL	Reports the telco echo return loss (read only)
TERLE	Reports the telco echo return loss enhancement (read only)
UID	Reports the unit identification number
VER	Reports the current firmware version

### AA

This command activates and deactivates the auto-answer feature.

**Command form:** DEVICE **AA** <X>

**Explanation:** <X> is the action (i.e. auto-answer enable, auto-answer disable, current state)

- X=0          Parameter disables auto-answer
- X=1          Parameter enables auto-answer
- X=2          Parameter to toggle the state from one state to the other  
(regardless of current state)
- X= Null      Parameter to report back the current state.

### DIAL

DTMF tones can be generated through the AP10. This capability remains active after a call is placed, so tones can be issued for use with voice mail and pagers. If the AP10 is not connected when this command is issued, the unit will connect to the line first, then dial the tone(s).

**Command form:** DEVICE **DIAL** <STRING>

**Explanation:** <STRING> is any valid combination of touch tone characters. A comma indicates a two-second pause. STRING has a maximum length of 40 characters. Valid characters are: 0 through 9, #, \* and ,

**Return values:** DIAL returns the dialed string of numbers. The string is returned after the command has been completed (i.e. dialed all the touch tones).

**Example:** The following command dials the number (801) 975-7200. A 9 and a pause is generated to get an outside line on a PBX.

The number is to be dialed on device #20.      #20 DIAL 9,8019757200  
The following is returned out the serial port:   #20 DIAL 9,8019757200

## HOOK

This command sends a momentary interruption in line seizure (hook flash) to the telephone line. This command is write-only.

**Command form:** DEVICE **HOOK**

**Return values:** If hook flash succeeded, the following is returned out the serial port: DEVICE HOOK

**Example:**

The command to request hook flash on device 20:      #20 hook  
The following is returned out the serial port:      #20 hook

## HOOKD

This command changes or reports the hook flash duration of the unit.

**Command form:** DEVICE **HOOKD** <X>

**Explanation:** <X> is the action (i.e. hook flash duration, current state)

X=0	Parameter to set hook flash duration to 50ms
X=1	Parameter to set hook flash duration to 500ms
X=NULL	Parameter to report back the current state.

**Return values:** The command will return the hook flash duration of the unit in the same format as the command. HOOKD <X>

**Example:**

The following command requests hook flash duration:   HOOKD  
The following is returned out the serial port:       HOOKD 4



## LVL

This command reports back the transmit or receive level for a unit.

**Command form:** DEVICE **LVL** <CH>

**Explanation:** <CH> is which parameter to be measured.

- CH=RXIN Parameter for level from the telephone line
- CH=RXOUT Parameter for level from the AP10
- CH=TXIN Parameter for level into the AP10
- CH=TXOUT Parameter for level to the telephone line

**Return values:** LVL will return the output level of the line channel in the same format as the command.

**Example:** If the current level for RXIN channel is -20dBu, the following is returned out the serial port: DEVICE LVL RXIN -20

## MUTE

This command controls or reports the mute status of a channel.

**Command form:** DEVICE **MUTE** <CH> <X>

**Explanation:**

<CH> is the channel(s) to be muted/unmuted.

- CH=T Parameter to apply to the transmit channel
- CH=R Parameter to apply to the receive channel
- CH=\* Parameter to apply to both channels

<X> is the action (i.e. mute, unmute, report the mute state).

- X=0 Set mute to off
- X=1 Set mute to on (mute the selected channel)
- X=2 Parameter to toggle the state from one state to the other (regardless of current state)
- X=NULL Report the current state of mute for the selected channel

**Return values:** MUTE returns the mute status in the same format as the command.

**Example:**

If current state of mute for channel T is muted, the following is returned out the serial port: DEVICE MUTE T 1

If current state of mute for channel T is unmuted, the following is returned out the serial port: DEVICE MUTE T 0

## NULL

This command sends a short noise burst down the telephone line and forces the AP10 to adapt to the telephone line. This command is write-only.

**Command form:** DEVICE NULL

Return Values: If the renull succeeded, the following is returned: DEVICE NULL

## RING

When the AP10 receives a ring at the dialed-up location, the AP10 will respond:

Device **RING**

## TE

Controls and reports the connection status of the unit.

**Command form:** DEVICE TE <X>

**Explanation:** <X> is the action (i.e., connect, disconnect, current state)

X=0	Parameter to set the unit to disconnect from the line
X=1	Parameter to set the unit to connect to the line
X=2	Parameter to toggle the state from one state to the other (regardless of current state)
X=NULL	Parameter to report back the current state

**Return values:**

If the current connect state is on, the following returns: DEVICE TE 1

If the current connect state is off, the following returns: DEVICE TE 0

**Examples:** To connect the unit to the telephone line: #20 TE 1

To report the connection state of the unit: #20 TE

## TERL

This command reports back the telephone echo return loss (ERL) for the AP10 in dB. This is a read-only parameter.

**Command form:** DEVICE TERL

**Return values:**

If the current TERL level is 10 dB, the following is returned: DEVICE TERL 10



## TERLE

This command reports back the telephone echo return loss enhancement (ERLE) for the AP10 in dB. This is a read-only parameter.

**Command form:** DEVICE **TERLE**

**Return values:** If the current TERLE level for the telephone canceller is 20dB, the following is returned out the serial port: DEVICE TERLE 20

## UID

This command returns the unique ID number of the unit. This command is read-only.

**Command form:** DEVICE **UID**

**Return values:** UID returns the unit ID code. The Unit ID is composed of an eight-digit hex number (assigned at the factory) to uniquely identify the unit.

**Example:**

To request the unit ID:	#20 UID
The following is returned out the serial port:	#20 UID A4EF906C

## VER

This command returns current version of firmware. This version is unique to a released version of firmware. This command is read-only.

**Command form:** DEVICE **VER**

**Return values:** VER returns the version of firmware (a major version number followed by a period and a minor version number).

**Example:**

To request the unit ID from device 20	#20 VER
The following is returned out the serial port:	#20 VER 1.1



## Appendix D: Warranty

ClearOne Communications, Inc. (Manufacturer) warrants that this product is free of defects in both materials and workmanship. Should any part of this product be defective, the Manufacturer agrees, at its option, to:

- A. Repair or replace any defective part free of charge (except transportation charges) for a period of one year from the date of installation for the end-user, provided the owner returns the product to the Manufacturer at the address set forth below. No charge will be made for parts or labor during this period;
- B. Furnish replacement for any defective parts in the product for a period of one year from the date of original purchase. Replacement parts shall be furnished without charge, except labor and transportation.

This Warranty excludes assembled products not manufactured by the Manufacturer whether or not they are incorporated in a Manufacturer product or sold under a Manufacturer part or model number.

### **THIS WARRANTY IS VOID IF:**

- A. The product has been damaged by negligence, accident, act of God, or mishandling, or has not been operated in accordance with the procedures described in the operating and technical instructions; or,
- B. The product has been altered or repaired by other than the Manufacturer or an authorized service representative of the Manufacturer; or,
- C. Adaptations or accessories other than those manufactured or provided by the Manufacturer have been made or attached to the product which, in the determination of the Manufacturer, shall have affected the performance, safety or reliability of the product; or,
- D. The product's original serial number has been modified or removed.

NO OTHER WARRANTY, EXPRESS OR IMPLIED, INCLUDING WARRANTIES OF MERCHANTABILITY OR FITNESS FOR ANY PARTICULAR USE, APPLIES TO THE PRODUCT. MANUFACTURER'S MAXIMUM LIABILITY HEREUNDER SHALL BE THE AMOUNT PAID BY THE END-USER FOR THE PRODUCT. No person or entity authorized to assume any obligation or other liability in connection with the products. No action, regardless of form, arising out of or relating to the product or this Warranty, may be brought by end-user more than one (1) year after the cause of action has accrued.





Manufacturer shall not be liable for punitive, consequential, or incidental damages, expenses, or loss of revenue or property, inconvenience, or interruption in operation experienced by the end user due to a malfunction in the purchased product. No warranty service performed on any product shall extend the applicable warranty period.

In case of unsatisfactory operation, the end-user shall promptly notify the Manufacturer at the address set forth below in writing, giving full particulars as to the defects or unsatisfactory operation. Upon receipt of such notice, the Manufacturer will give instructions respecting the shipment of the product, or such other matters as it elects to honor this warranty as above provided. This warranty does not cover damage to the product during shipping and the Manufacturer assumes no responsibility for such damage. All shipping costs shall be paid by the customer.

This warranty extends only to the original end user and is not assignable or transferable. This Warranty is governed by the laws of the State of Utah, without regard to the conflicts of interests provisions thereof.

ClearOne Communications, Inc.  
1825 Research Way  
Salt Lake City, Utah 84119

## Appendix E: Compliance

### FCC Part 15 Compliance

This equipment has been tested and found to comply with the limits for a Class A digital device, pursuant to Part 15 of the FCC rules. These limits are designed to provide reasonable protection against harmful interference when the equipment is operated in a commercial environment. This equipment generates, uses, and can radiate radio frequency energy and, if not installed and used in accordance with the instruction manual, may cause harmful interference to radio communications. Operation of this equipment in a residential area is likely to cause harmful interference, in which case the user will be required to correct the interference at his/her own expense.

Changes or modifications not expressly approved by ClearOne Communications, Inc. could void the user's authority to operate the equipment.

### FCC Part 68 Compliance

**FCC Registration Number: FBIUSA-43110-BR-T**

**Ringer Equivalence Number (REN): 0.6B**

A label containing, among other information, the FCC registration number and Ringer Equivalence Number (REN) for this equipment is prominently posted on the top plate, near the rear of the equipment. If requested, this information must be provided to your telephone company.

**USOC Jacks: This device uses RJ-11C and RJ21X terminal jacks.**

The REN is used to determine the quantity of devices which may be connected to the telephone line. Excessive RENs on the telephone line may result in the devices not ringing in response to an incoming call. In most, but not all areas, the sum of the RENs should not exceed five (5). To be certain of the number of devices that may be connected to the line, as determined by the total RENs, contact the telephone company to obtain the maximum RENs for the calling area.

If this equipment causes harm to the telephone network, the telephone company will notify you in advance that temporary discontinuance of service may be required. If advance notice is not practical, the telephone company will notify the customer as soon as possible. Also, you will be advised of your right to file a complaint with the FCC if you believe it is necessary.

The telephone company may make changes in its facilities, equipment, operations, or procedures that could affect the operation of the equipment. If this happens, the telephone company will provide advance notice for you to make the necessary modifications in order to maintain uninterrupted service.

If you experience problems with this equipment, contact ClearOne Communications, Inc., 1825 Research Way, Salt Lake City, Utah 84119, or by phone at (801) 975-7200 for repair and warranty information. If the trouble is causing harm to the telephone network, the telephone company might request that you remove the equipment from the network until the problem is resolved.

No user serviceable parts are contained in this product. If damage or malfunction occurs, contact ClearOne Communications for instructions on its repair or return.

This equipment cannot be used on telephone company provided coin service. Connection to Party Line Service is subject to state tariffs.

## IC Compliance

NOTICE: The Industry of Canada label identifies certified equipment. This certification means that the equipment meets certain telecommunications network protective operational and safety requirements. The Department does not guarantee the equipment will operate to the user's satisfaction.

Before installing this equipment, users should ensure that it is permissible to be connected to the facilities of the local telecommunications company. The equipment must also be installed using an acceptable method of connection. In some cases, the company's inside wiring associated with a single line individual service may be extended by means of a certified connector assembly (telephone extension cord). The customer should be aware that compliance with the above conditions may not prevent degradation of service in some situations.

Repairs to certified equipment should be made by an authorized Canadian maintenance facility designated by ClearOne Communications. Any repairs or alterations made by the user to this equipment, or equipment malfunctions, may give the telecommunications company cause to request the user to disconnect the equipment.

Users should ensure for their own protection that the electrical ground connections of the power utility, telephone lines and internal metallic water pipe system, if present, are connected together. This precaution may be particularly important in rural areas.

**Ringer Equivalence Number (REN): 0.6B**  
**IC Certification Number: 1970 11504 A**

## Safety Information

CAUTION: Users should not attempt to make such connections themselves, but should contact the appropriate electrical inspection authority, or electrician, as appropriate.

**Appendix F: Block Diagram**

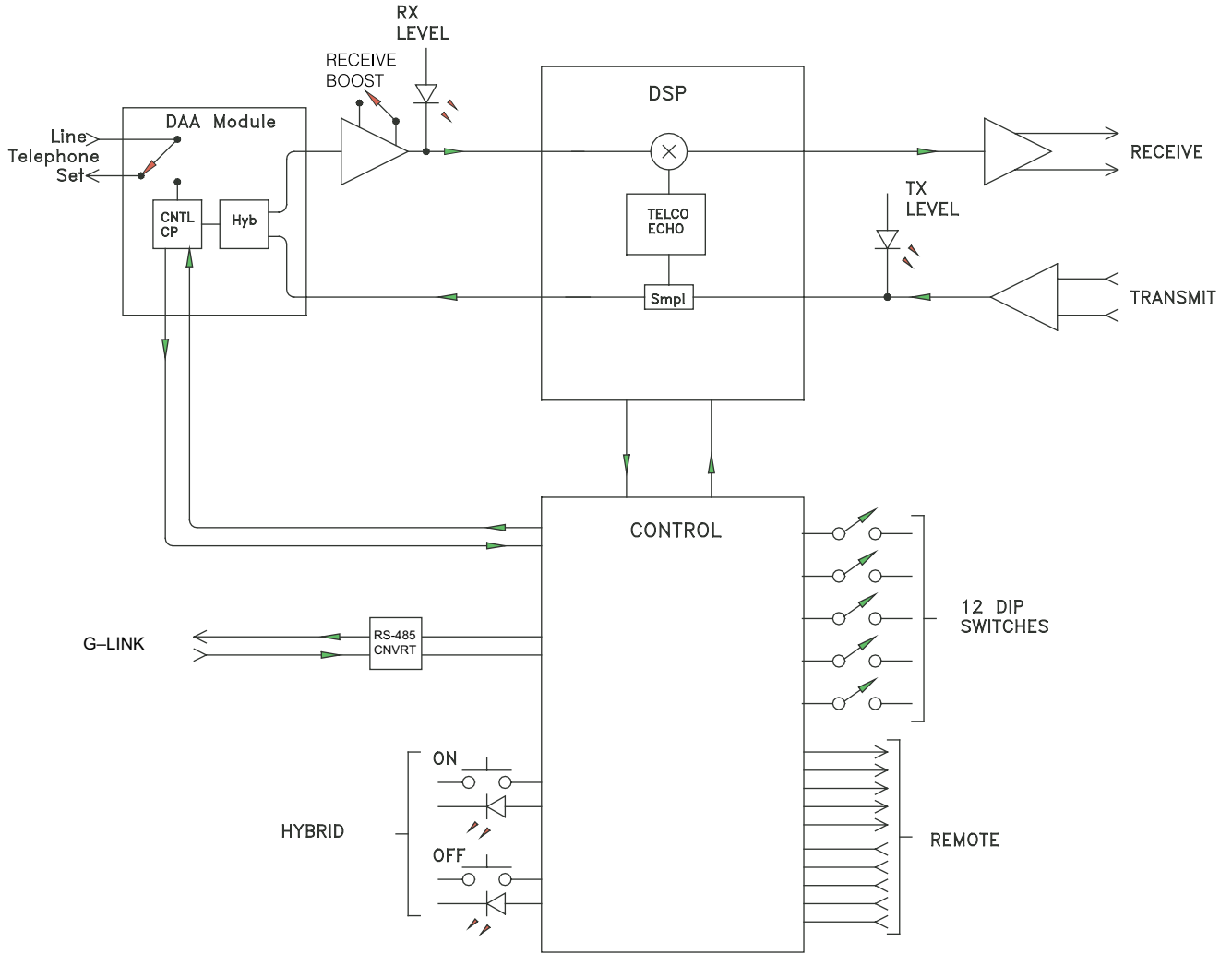

## Glossary

**Acoustic Echo Cancellation (AEC)** A process in which acoustical echo is removed from a signal. AEC can be used to remove unwanted signals from mic audio if the unwanted acoustic signal is available separately as an electronic signal.

**Ambient Noise** The existing room-level noise, such as that caused by ventilation systems, paper shuffling, and background chatter.

**Attenuation** A reduction of signal amplitude.

**Automatic Gain Control (AGC)** Automatically increases or decreases audio gain to maintain a consistent audio level.

**Automatic Microphone Mixer** A microphone mixer that automatically activates and deactivates microphone channels. This serves to increase intelligibility of the audio by reducing reverberation and noise picked up by the microphones.

**Clipping** A condition in which a signal level exceeds the maximum level a circuit can handle. This is usually caused by overdriving an input. It always causes distortion and typically leads to listener fatigue and accelerated failure of loudspeaker drivers.

**Digital Hybrid** A telephone hybrid that uses digital signal processing to provide excellent audio separation between the send and receive audio paths.

**Distributed Echo Cancellation** ClearOne's proprietary system for applying echo cancellation individually to each mic input. Used in AP800 and AP400 units.

**Digital Signal Processor (DSP)** A high speed digital numeric processor that can rapidly calculate complex mathematical equations. The DSP is the most important component used in ClearOne digital products.

**Echo Cancellation** The process in which acoustic echoes are canceled. This is accomplished by sampling the distant audio that is amplified through the loudspeaker in the room. When this audio is picked up by the microphone (this is acoustic echo), an echo canceller eliminates or "cancels" the echo.

**Four Wire** Typically refers to audio in and out of a video codec.

**G-Link** A high speed digital network bus used to link AP800, AP400, and AP10 units.

**Integrated Dialing** The ability of a telephone hybrid to dial (generate touch tones) via an RS-232 serial connection.

**Matrix mixer** A mixer that allows routing of any input or combination of inputs to an output or any combination of outputs.

**Omni-directional Microphone** A microphone that picks up audio in a 360-degree pattern.

**Reverberation** Audio in a room that bounces off a wall, ceiling, table or other objects and then is picked up by microphone. High reverberation causes listener fatigue and makes audio difficult to understand.

**Simultaneous Two Wire/Four Wire** The ability of a teleconferencing device to connect to a video codec and a telephone line simultaneously.

**Sound Pressure Level (SPL)** The measure of acoustical audio in the air. Is measured in dB using an SPL meter.

**Telephone Hybrid** A term used to refer to a telephone interface that separates send and receive audio. Same as a digital hybrid.

**Two Wire** Typically refers to a telephone line.

**Uni-directional Microphone** A microphone that picks up audio in a directional (usually 180 degrees or less) pattern.

**Index****A**

answer a call 15  
AP-Ware 15, 16  
AP10 3  
    connecting the unit 7  
    control 17  
    features 2  
    front-panel controls 3  
    operation 15  
    rear-panel connectors 4  
auto-adapt 11, 13, 14  
auto-answer 3, 11, 12, 15, 17, 23  
auto-disconnect 11, 12, 15

**C**

calibration 13  
call progression 11, 12, 14  
control 17

**D**

device ID 7, 9  
dial 23  
digital signal processing 1  
DIP switches 3, 19  
    settings 11  
disconnect a call 15, 16  
DTMF dialing 2, 17

**E**

ERL 17  
ERLE 17  
error 9

**F**

frequency response 19

**G**

G-Link In, Out 4, 8, 19  
G-Link network 2, 7, 8  
G-Link terminator 8

**H**

hook-flash 17, 24  
hook-flash duration 11, 24

**L**

line connector 21  
loop drop 11, 12, 14

**M**

make a call 15, 16  
meter 17  
mute 15, 17, 25

**N**

noise burst 11, 13, 26  
null 26

**P**

pinouts 17, 20  
power 4, 10, 19  
Professional Services Group 1

**R**

re-null 17  
receive AGC 11, 12  
receive boost 11  
receive LED 3, 9  
receive level 14, 25  
receive output 4, 8, 19  
receive reduction 11, 13  
registration 2  
remote connector 8, 20  
returns 2

**S**

serial command 15, 22  
set connector 21  
specifications 19

**T**

telco echo cancellation 2, 19

Telco interface 15, 16

telco line 4

telco set 4

TERL 26

TERLE 27

tip and ring 4

transmit input 4, 8, 19

transmit LED 3, 9

transmit level 14, 25

**V**

version 27

**W**

white noise 11, 13